

**“Anal cancer chemoradiotherapy”
Evidence and guidelines**

Dr Ajay Gupta

**Associate Professor & Senior Radiotherapist
VMMC & Safdarjang Hospital, New Delhi**

Background

- Carcinomas in the anal canal account for about 1.5% of gastrointestinal cancers in the United States, and approximately 80% of these are **squamous cell carcinomas (SCCs)**.
- SCCs of the anus are frequently related to chronic infection with **human papilloma virus (HPV)**

Background

- Usually occur in the sixth to seventh decade of life
- Occur in younger patients when immuno compromised
- Male:Female=2:1
- HIV/AIDS, and the increasing use of immunosuppressive therapy for solid organ transplantation, inflammatory bowel disease and collagen vascular diseases has meant an **increasing incidence of HPV infection and anal SCC**

Anal tumours - pathology

- SCC
- Basaloid*
- Cloacogenic (transitional)*

SCC : 80%

*** Variants of SCC.**

- Adenocarcinoma
- Melanoma
- Sarcoma
- Lymphoma
- carcinoid
- Undifferentiated

Anal Cancer: Just the Facts

- **Anatomy:**

- 3-4 cm anal canal
- Anal verge to dentate line

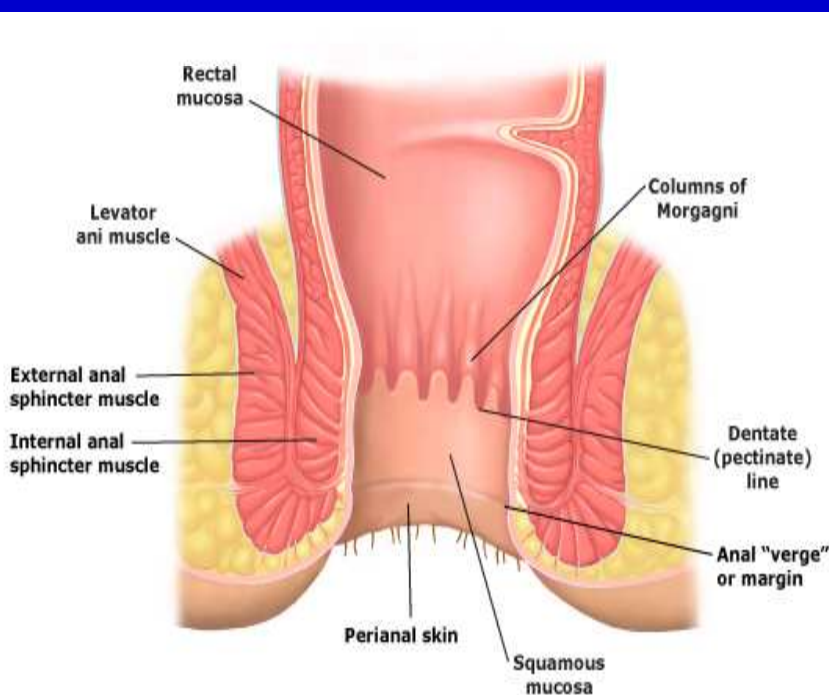

- **Lymph node drainage:**

- Perirectal
- Internal iliac
- Inguinal nodes

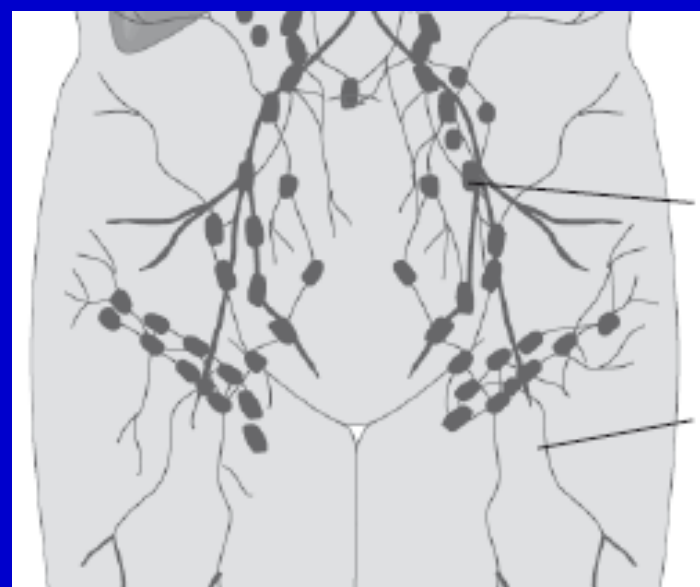

(Up-to-date; cancerbackup.org)

Anal tumours - staging

- **History**
- **Examination in clinic if possible – abdo / groins / PR**
- **EUA with biopsy**
- **? FNA of any groin nodes**
- **CT scan**
- **MRI scan**
- **(Endoanal U/S)**

Utility of Other Tests

- PET scans
 - Nagle – 14 patients
 - Sensitivity = 50%, specificity = 72%, predictive value positive (PVP) = 50%, predictive value negative = 80%
 - Trautman – 24 patients
 - 24% had disease not seen on CT scans
 - Cotter – 41 patients
 - 20% had groin nodes negative on CT scan
 - 23% had groin nodes negative on physical examination
 - 91% had primary tumor identified vs. 59% on CT scan
- Ultrasound
 - Giovanni – 146 patients
 - Advantage was in determining complete response

Anal canal - TNM

- Tis carcinoma *in situ*
- T1 tumour 2cm or less
- T2 tumour 2 - 5cm
- T3 tumour 5cm or more
- T4 tumour invading adjacent organs

- N0 No nodes
- N1 perirectal LN metastases
- N2 unilateral int iliac ± inguinal LN
- N3 bilateral int iliac + ing and perirectal LN

Surgical Treatment

- **Abdominoperineal resection**
 - Local failures range from 27-47%
 - 5-year survivals range from 50-70%

Radiotherapy:

Reasonable alternative to surgery

Radiation therapy alone :

- 5 year survival : 39 - 76%
- Colostomy - free survival : 67 - 74%
- Doses \geq 60 Gy : necrosis and fibrosis

Combination Therapy – Wayne State

- 1970s - investigators preoperatively administered fluorouracil and mitomycin combined with RT to decrease the surgical failure rate:
 - 5-FU (1000 mg/m² per day, days 1-4 & 29-32)
 - Mitomycin (10 to 15 mg/m², day 1 only)
 - Intermediate dose RT (30 Gy in 15 fractions via AP/PA fields to the true pelvis, medial inguinal LN, and primary lesion with margin)
- Surprisingly, first 3 patients had no residual tumor when abdominoperineal resection was performed
- Suggested it might be possible to cure anal cancer without permanent colostomy

Anal chemoradiotherapy

There have been many small trials using different forms of chemotherapy with varying types of radiotherapy

Started by Nigro in 1973

1980's....primary treatment started moving away from the surgeons

Anal chemoradiotherapy

- UKCCCR Anal Canal Trial 1 – 577 pts (ACT1) ¹
- EORTC trial – 110 pts ²

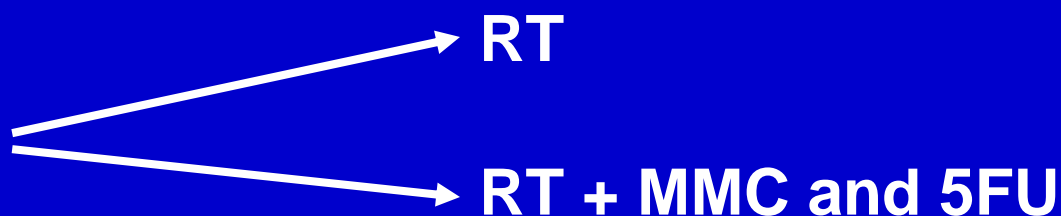

1: Lancet 348: 1049-1054, 1996

2: Bartelink et al, JCO, 15:2040-2049, 1997

UKCCCR Anal Cancer Trial (ACT 1)

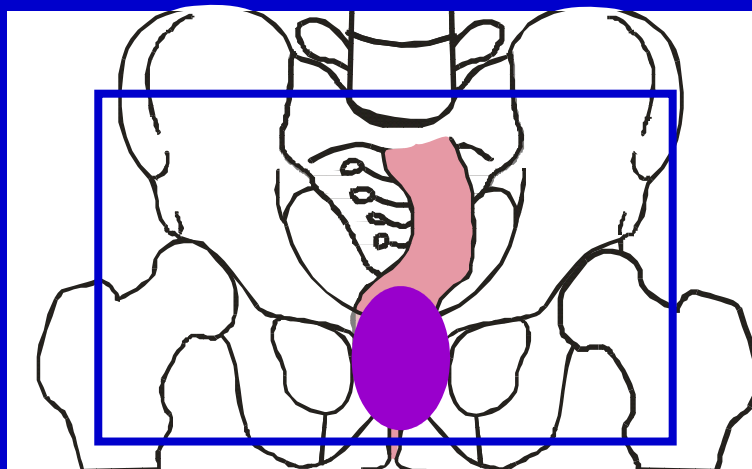
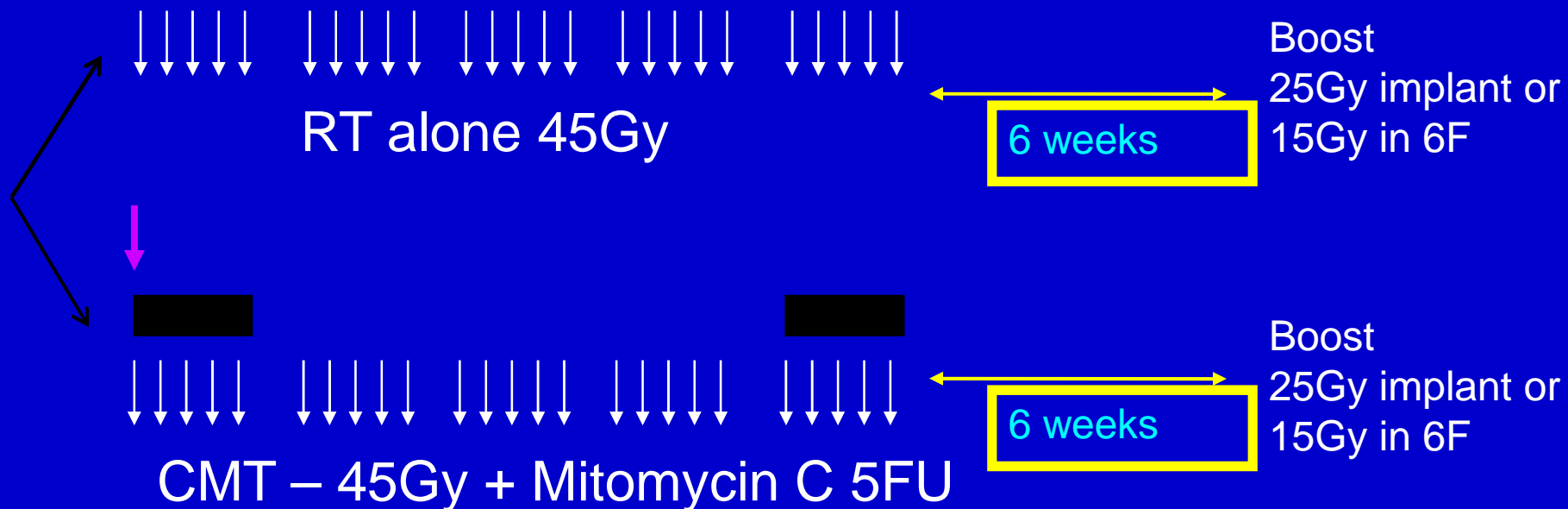

ACT I : Time to first local relapse

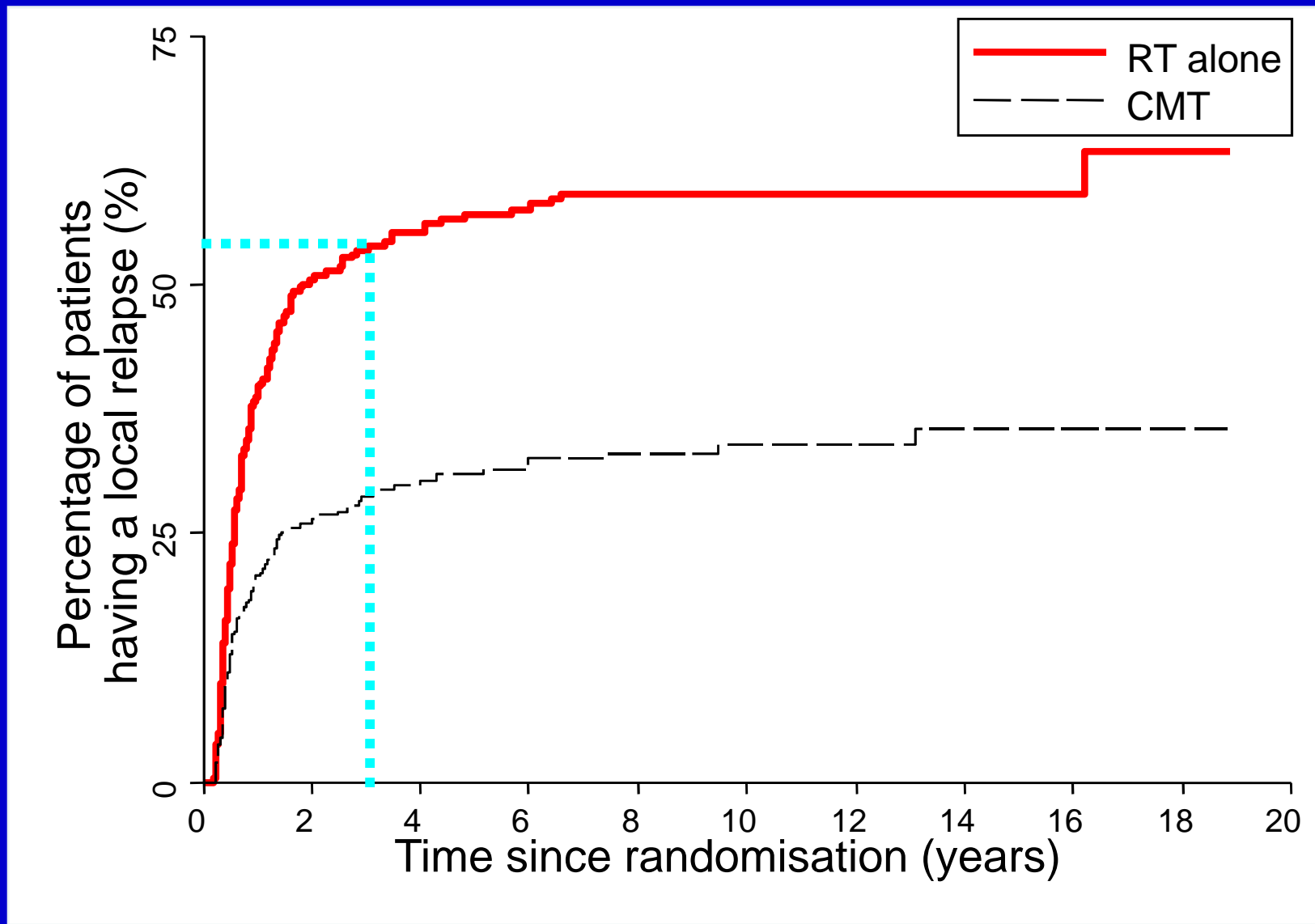

Colostomy-free survival

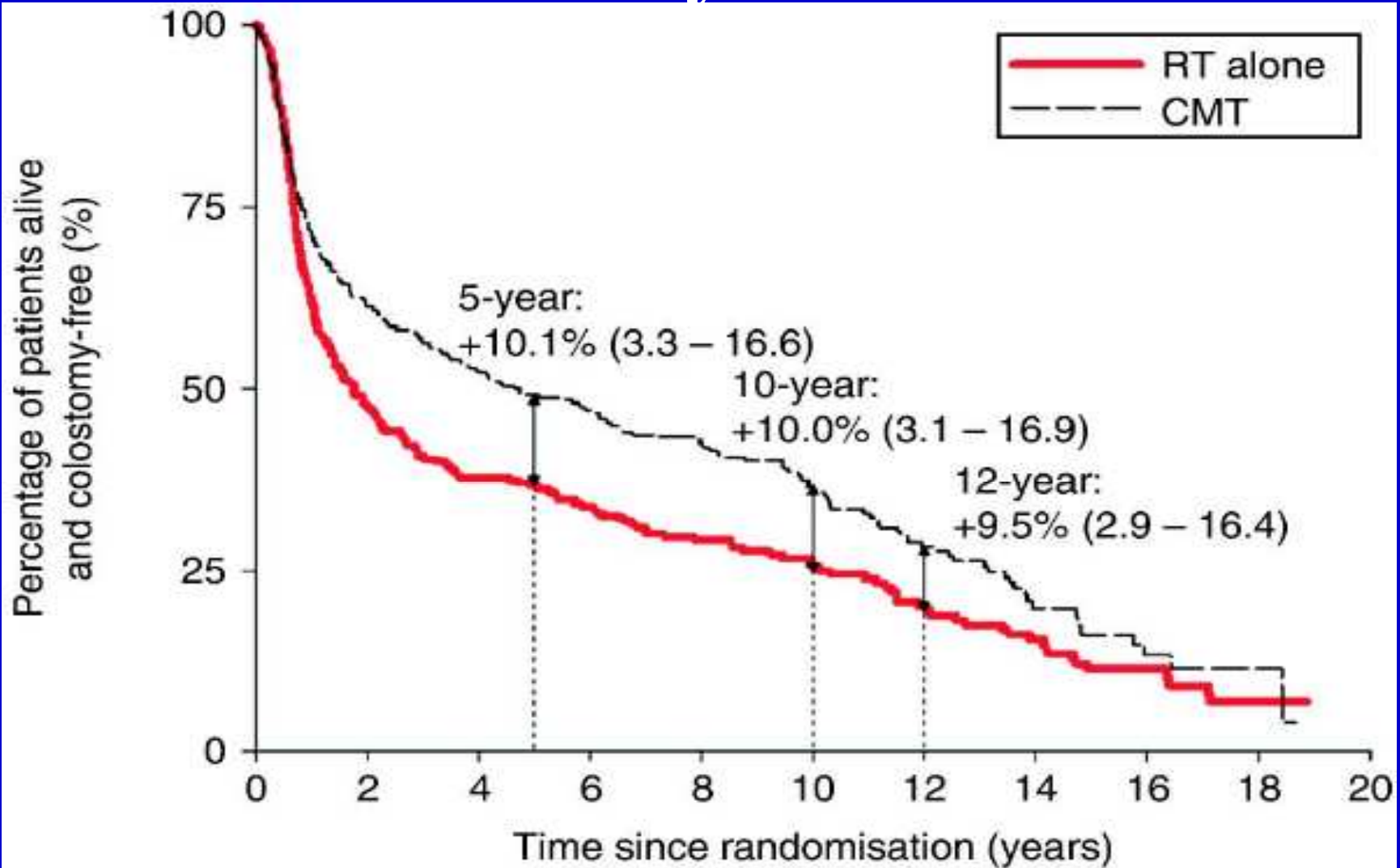

Number at risk:

RT alone :	285	132	101	86	64	47	31	24	12
CMT:	292	178	147	130	98	62	42	20	8

Figure 2: Overall survival, by treatment

The estimates shown are the absolute risk differences: CMT minus RT alone (95% CI)

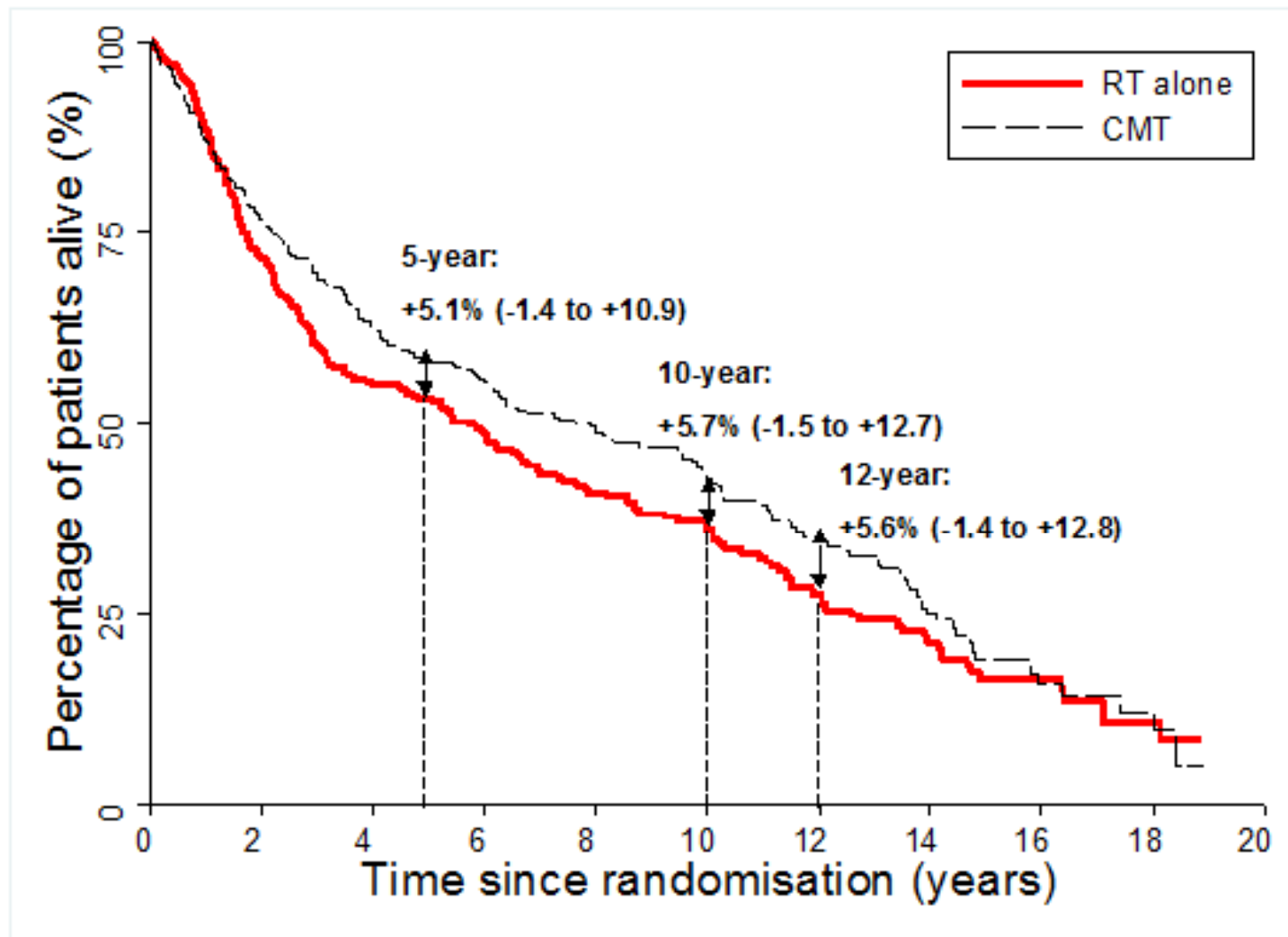

Number at risk:

RT alone:	285	199	149	126	94	65	39	30	14
CMT :	292	221	175	153	115	78	56	30	12

UKCCCR ACT 1 trial

- RT \pm MMC and 5FU chemotherapy
 - 45Gy phase I and then 15 Gy boost
 - MMC 12mg/m² d1; 5FU 1g/m² d1-4 and d29-32
- 577 pts
- Median FU of 42 months (3 ½ years)
- Local failure : RT 61% (p<0.0001)
CRT 39% (46% reduction in risk of failure)

Lancet 348, 1049-1054, 1996

UKCCCR ACT 1 trial.....but.....

- 46% had local treatment failure (265/577)
- Of these, 58% were considered suitable for salvage surgery
- The remaining 42% had a range of palliative treatments
- 50% were dead at 5 years (51 and 52% in each arm) *

Therefore anal cancer is not as treatable as some people may think. However, there is a chance of survival without colostomy which is not possible with primary surgery

*** Remember APR: 5 yr survival N0 50-70%, N+ 20%.**

Anal verge - treatment

- **Local resection with close FU**
(up to 80% 5 year survival)
- **AP resection**
- **Chemoradiotherapy**



Anal canal (N0) - treatment

- AP resection
- Chemoradiotherapy *

- * ? Defunctioning colostomy required
- * ? Anal canal damaged anyway and colostomy would be required even if tumour cured by CRT

Radiotherapy for Anal SCC

No standard approach

- **External beam alone with external beam boost ***
(* photon or electron)
- **External beam with brachytherapy implants**
- **Electron beam or brachytherapy only**

ACT II

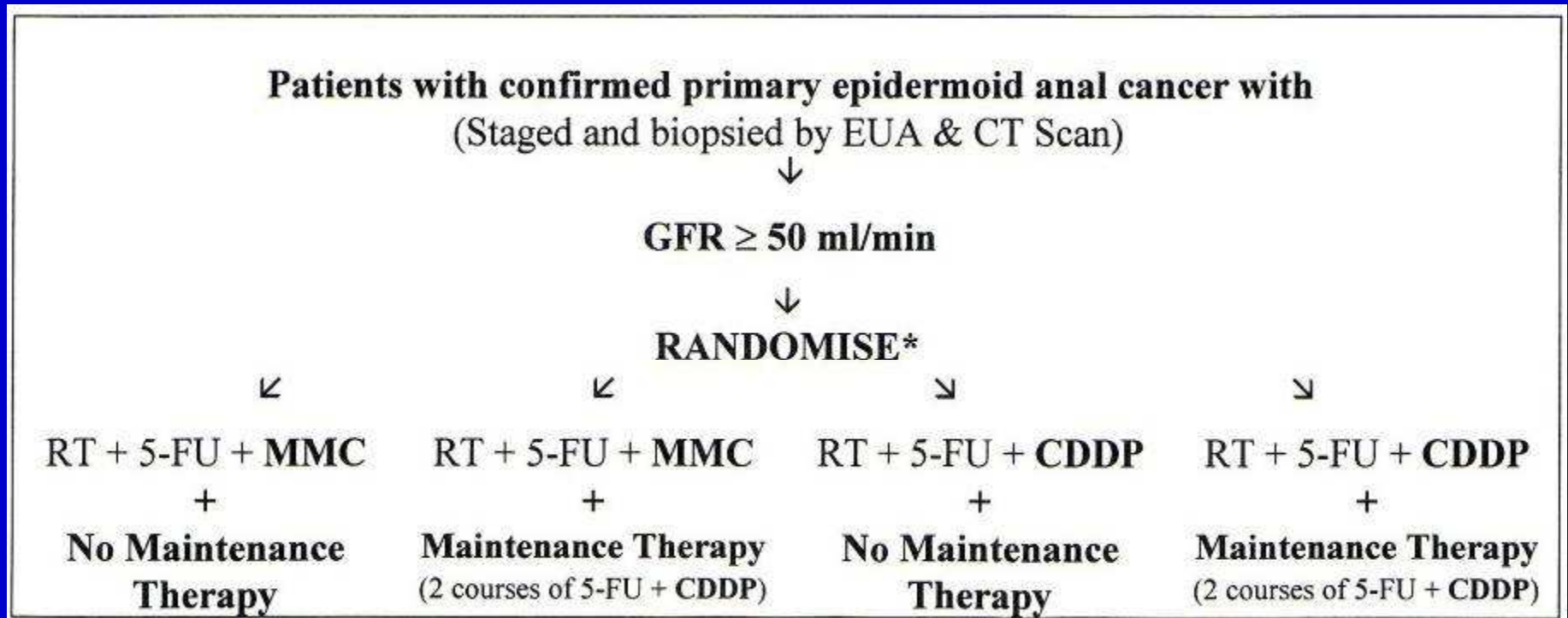

? Cisplatin better than MMC

? Maintenance therapy beneficial

Chemoradiation Regimens

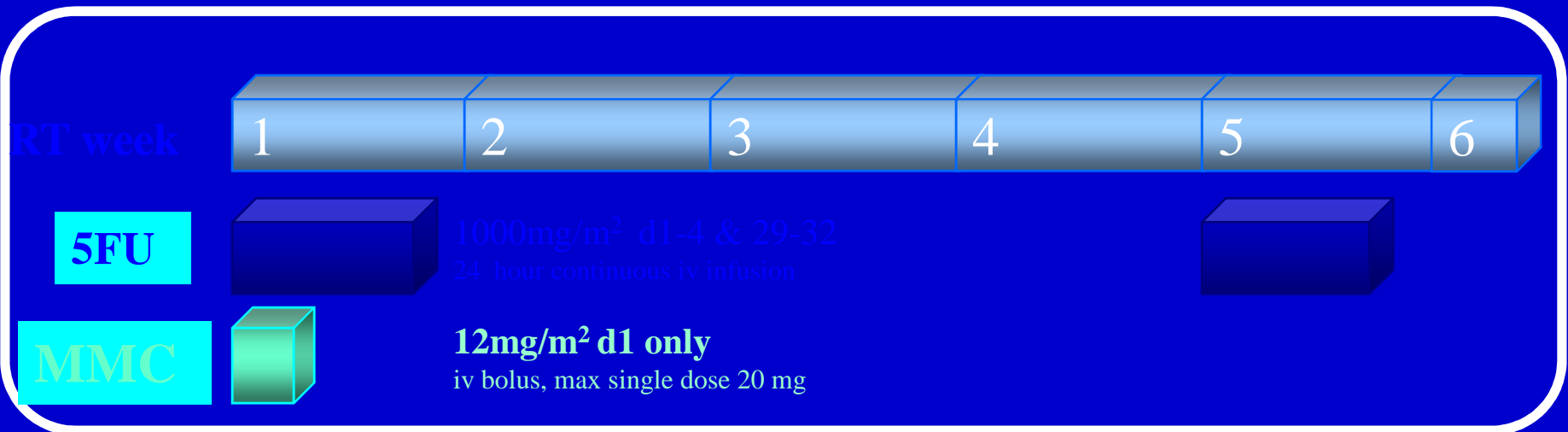

ACT II Endpoints

Chemoradiation (CRT) comparison

Primary Endpoints

- Complete response rate at 6 months
- Acute Toxicity (CTC Grade 3 & 4)

Maintenance comparison

Primary Endpoint

- Recurrence Free Survival

Both comparisons

Secondary Endpoints

- Colostomy Rate
- Cause-specific & Overall survival

ACT II - Radiotherapy

- **50.4 Gy** in **28** fractions in total (1.8Gy/#)
- 2 phase treatment – **no gaps** *



* Constantinous *et al*, 1997: Trend towards improved 5 year survival when treatment completed within 40 days (86% vs 60%, $p=0.14$).

ACT II – Phase 1

- **Large Ant/Post Parallel Opposed Portals**
 - include all macroscopic disease
 - include both inguino-femoral regions
- **Prone**
- **3060 cGy in 17 fractions**
 - Hu *et al*, 1999: 30-34Gy vs 50.4Gy for presumed microscopic residual disease following excision biopsy; no difference in local control.
 - Newman *et al*, 1992: 62 pts with no clinical or radiological evidence of groin nodes – only 5 relapsed at this site – all salvaged by groin dissection

Phase I - Parallel opposed fields 30.6 Gy in 17 daily fractions

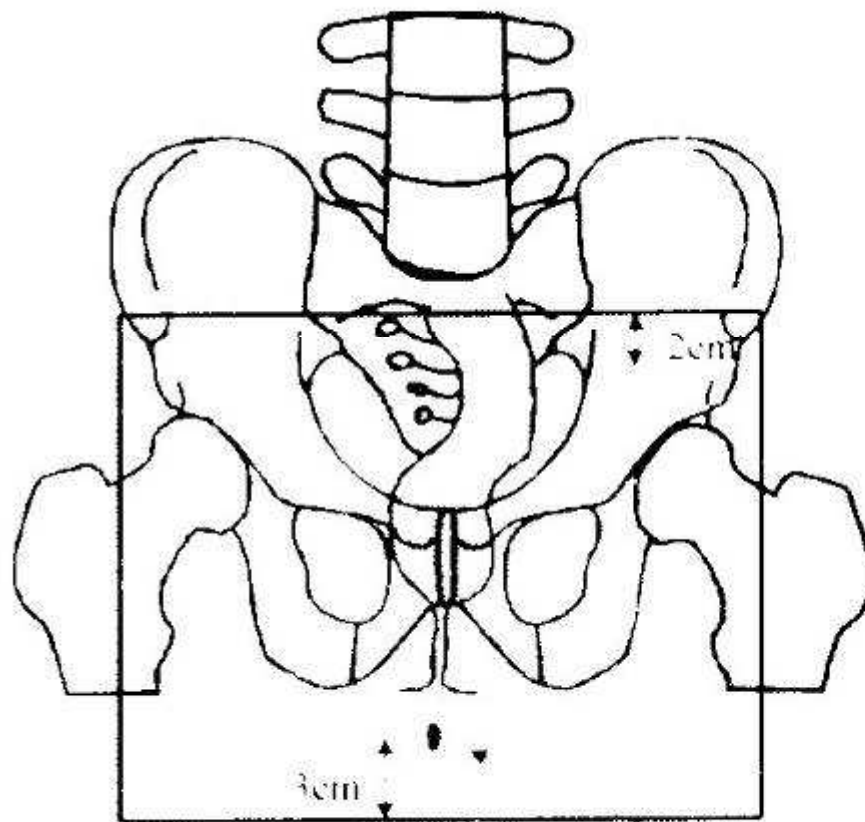

Sup border

2cm above bottom of SI joints

Inf border

3cm below anal margin (canal only tumours) or 3cm below most inferior extent of tumour (anal margin tumours)

Lateral border

lateral to femoral head to cover inguinal nodes

2 Marker on interior extent of tumour (anal margin tumour)

3 Marker on anal verge (canal only tumour)

© 2009 American College of Radiology. All rights reserved. 10/2009

ACT II – Phase 2

- Planned simultaneously with phase 1.
- Simulator or CT planning.
- **1980 cGy** in **11#** (1.8Gy/#).
- All visible tumour marked using radio-opaque marker (with rectal contrast in orthogonal films).
- 3 or 4 field plan.

Phase II - 19.8 Gy in 11 daily fractions planned volume

N0 patients (anal canal tumours) - field borders

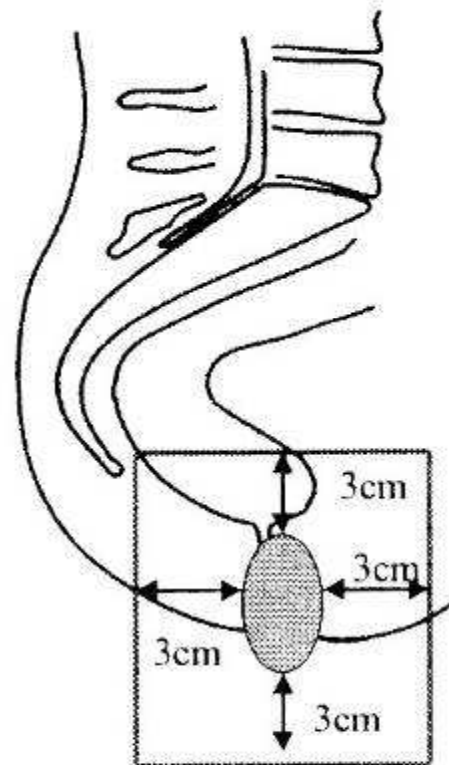
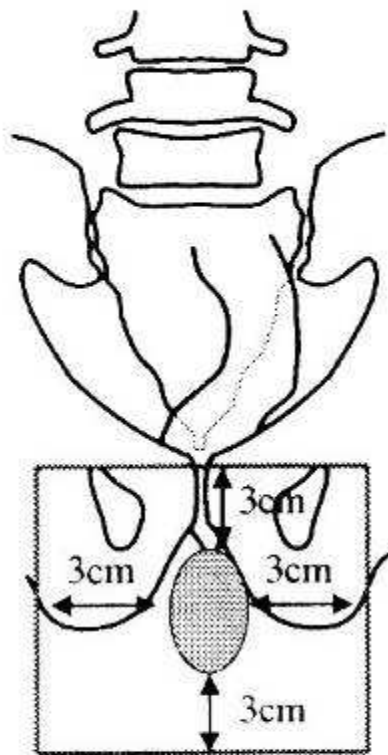

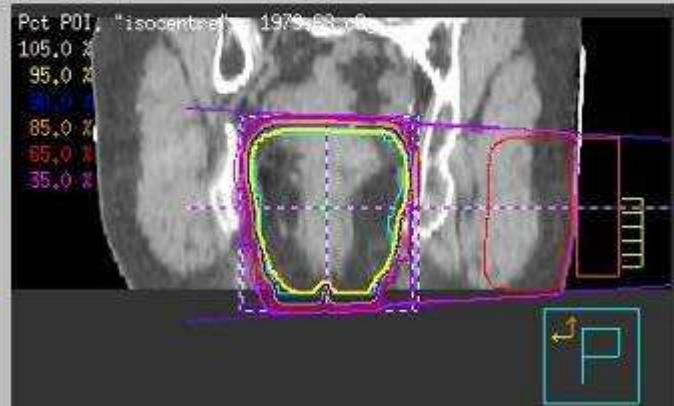
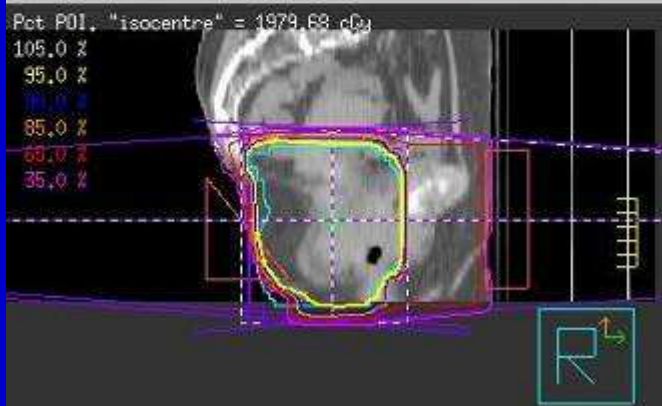
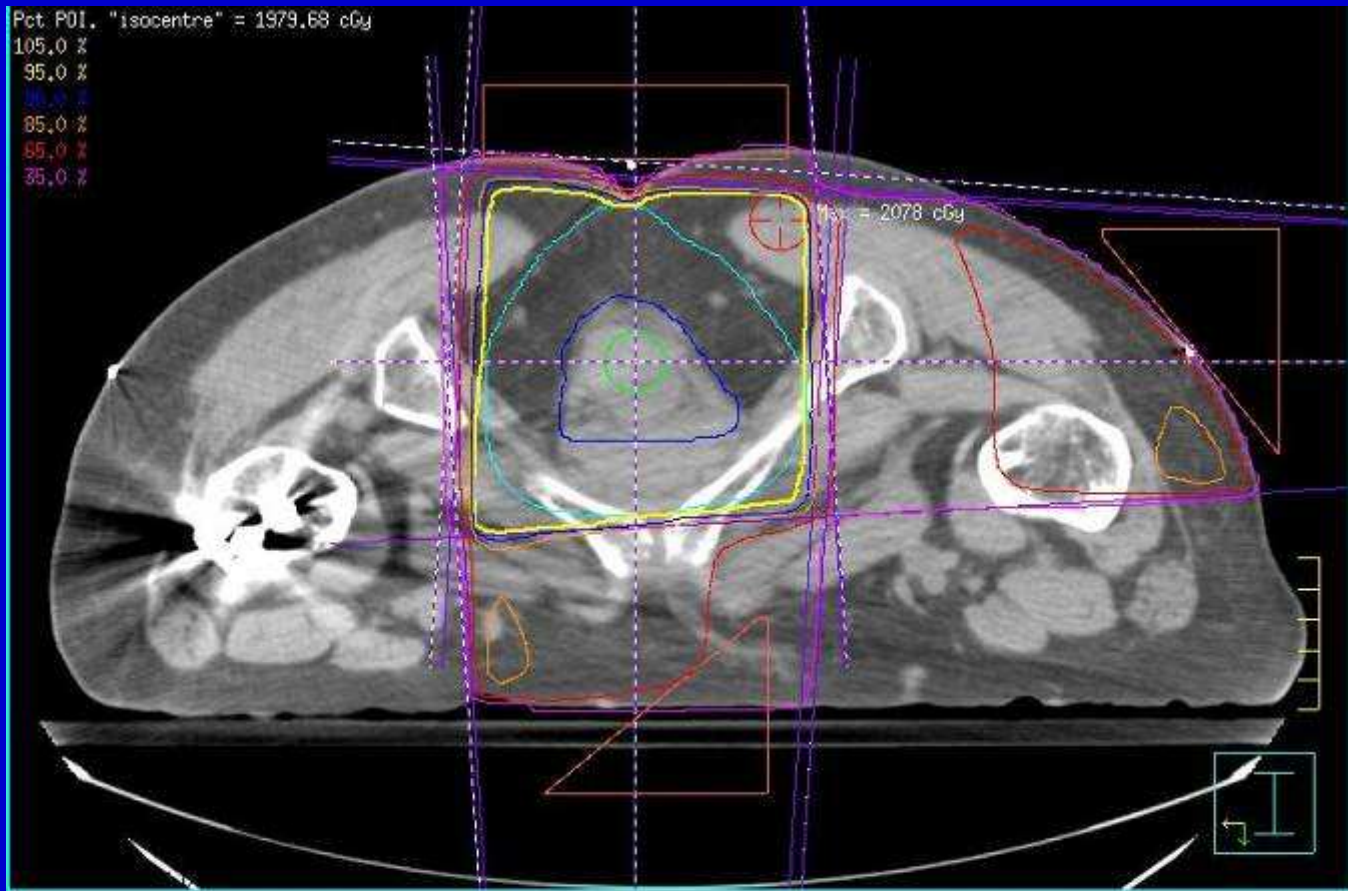

Problems 1

Positive inguinal nodes

(10% of pts)

- Chemoradiotherapy
- Also consider:
 - Primary surgery to both sites
 - Combination of surgery and CRT (RT dose may need to be lower and neo-adjuvant chemotherapy may be appropriate)
- Ask:
 - is this palliative or radical treatment



**75 year old
lady with
N3 disease**



ACT II – Phase 2

Phase II - 19.8 Gy in 11 daily fractions parallel opposed fields N+ patients

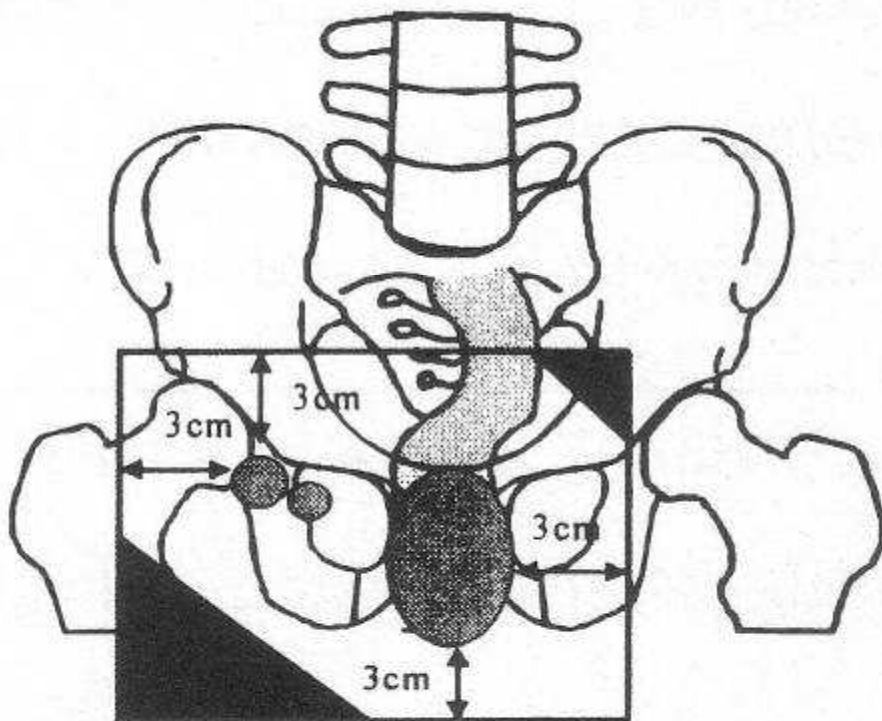

Sup field border

3cm above most superior extent of GTV

Inf field border

3cm below anal margin (canal only tumours) or 3cm below most inferior extent of tumour (anal margin tumours)

Lateral field border

3cm lateral to most lateral GTV

Tumour Stage

	MMC (472)	CisP (468)
T stage		
T1 T2	49% (232)	54% (254)
T3 T4	48% (225)	44% (205)
TX	15	13
N Stage		
Node negative	63% (297)	62% (290)
Node positive	32% (150)	33% (155)
NX	25	23

Response at 26 weeks

Patients with response data (863)	MMC (432/472)	CisP (431/468)	P=0.66
CR primary	90%	90%	
CR N0	83% (358)	84% (362)	
CR N+	3% (15)	3% (12)	
CR Nx	4% (18)	3% (12)	
PR	3% (14)	6% (24)	
SD	1% (5)	1% (6)	
PD	5% (22)	3% (15)	

ACT II Compliance & Toxicity

- Radiotherapy
 - 92% MMC vs 90% CisP - total dose 50.4Gy
 - ~3% >7 days interruptions
- Chemotherapy - weeks 1 & 5
 - 75% MMC vs 72% CisP full dose weeks 1 & 5
- Acute toxicity
 - 58% MMC vs 60% CisP Grade 3
 - 13% MMC vs 12% CisP Grade 4
 - 71% MMC vs 72% CisP combined Grade 3/4

CR at 26 weeks

		Difference (95% CI)	P value
MMC	CisP		
83% (358/432)	84% (362/431)	+1% (-3.8 to 6.1)	p = 0.66
No Maint	Maint		
82% (337/409)	85% (348/410)	+3% (-2.6 to 7.5)	p = 0.34

ACT II – Conclusions

- Excellent CR rate at 6 months - 83% v 84% - no difference MMC/Cisp
- No difference in colostomy rate
- No difference in PFS
- 60% of pts not in CR at 11 weeks achieved CR at 26 weeks.
- We recommend assessment at 26 weeks in future trials

Maintenance Comparison- Recurrence Free Survival

Event is progression, recurrence or death

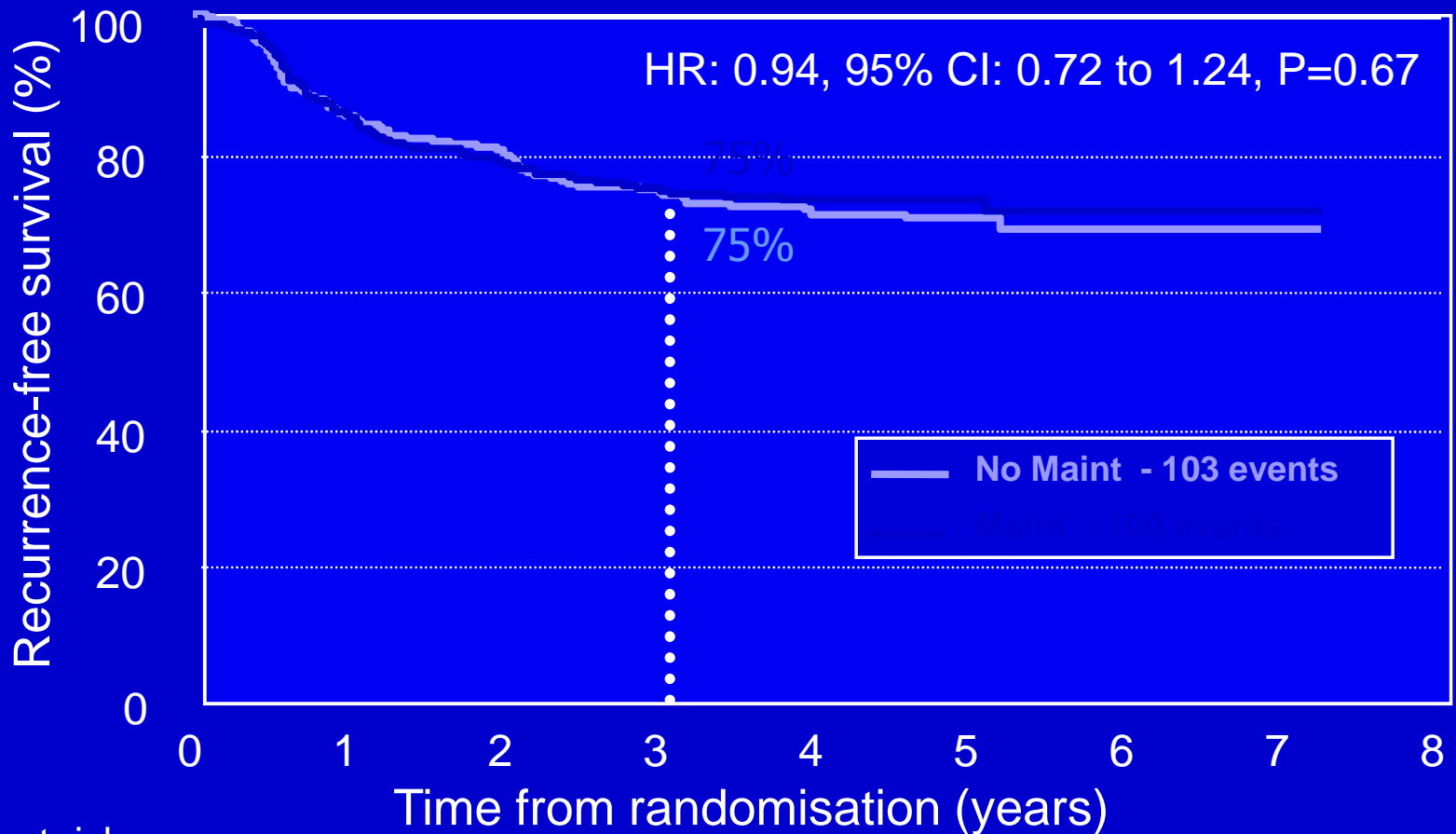

No. at risk

No Maint	472	346	263	183	116	67	19	4
Maintenance	468	345	251	183	132	61	16	1

Maintenance Comparison - Overall Survival

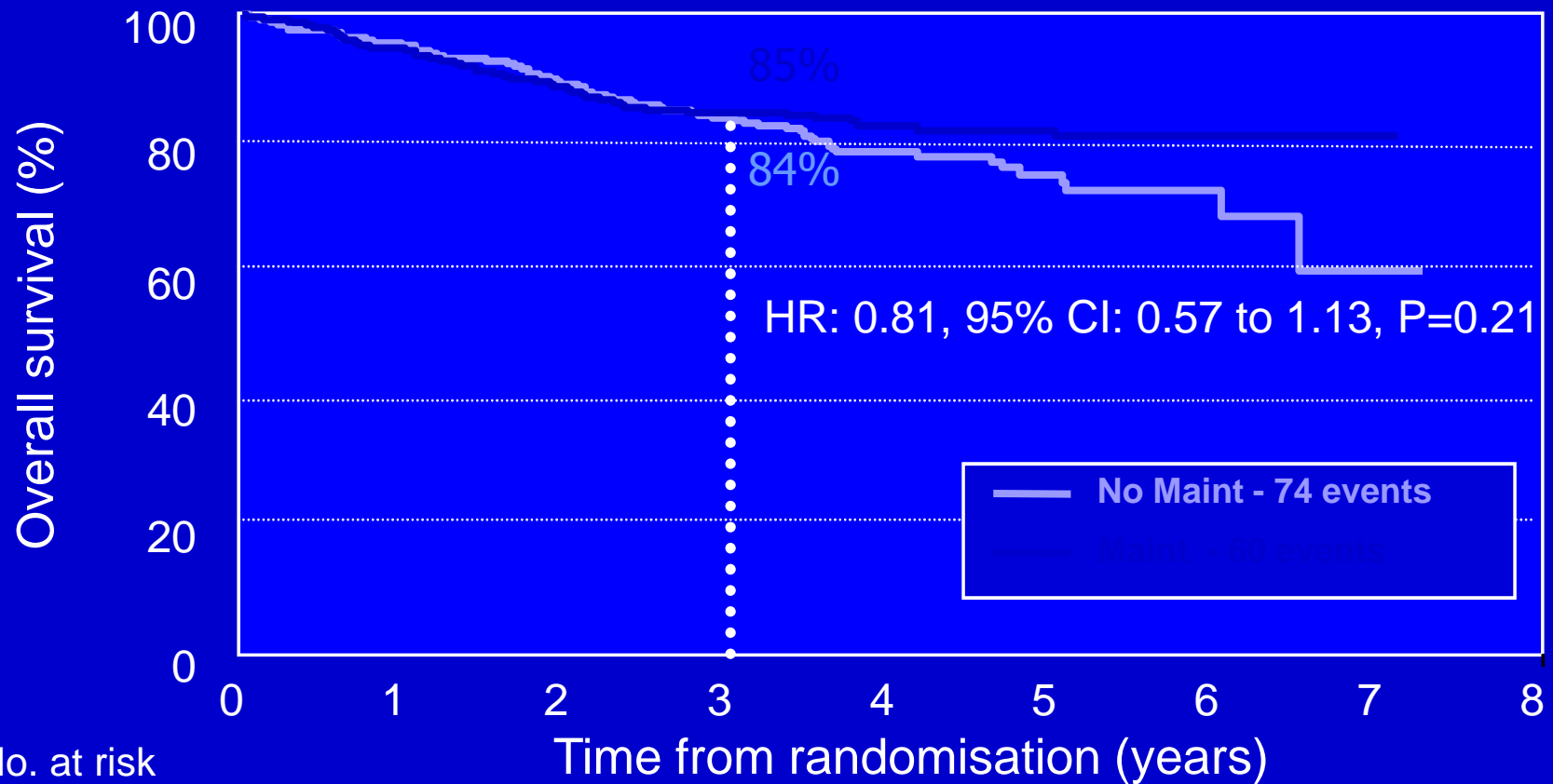

No. at risk

No Maint

446
448

369
361

278
278

198
203

125
138

67
71

19
22

4
3

ACT II – Conclusions 2

Maintenance comparison

- Preliminary data shown 2009
- Median follow-up now 5 years
- No evidence of any difference in PFS, cause specific survival or overall survival

ACT II Timing of pelvic recurrences (93% in years 1-3)

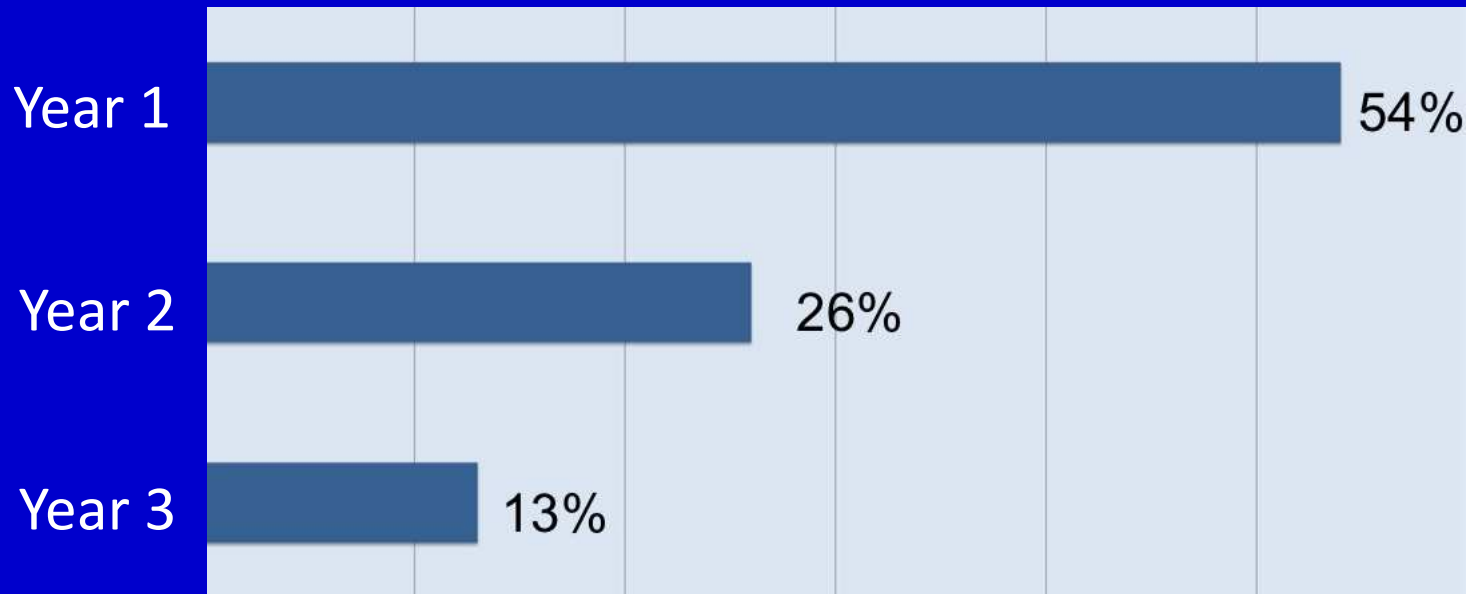

ACCORD- 03

- **Locally advanced >4cm or N1 anal canal**
- **Therapeutic intensification**
 - Induction chemotherapy
 - High dose radiotherapy
- **Primary endpoint: colostomy-free-survival(CFS).**
- **Secondary endpoint : QOL, local control (LC), overall survival (OS), and cancer-specific survival.**

ACCORD 03

R

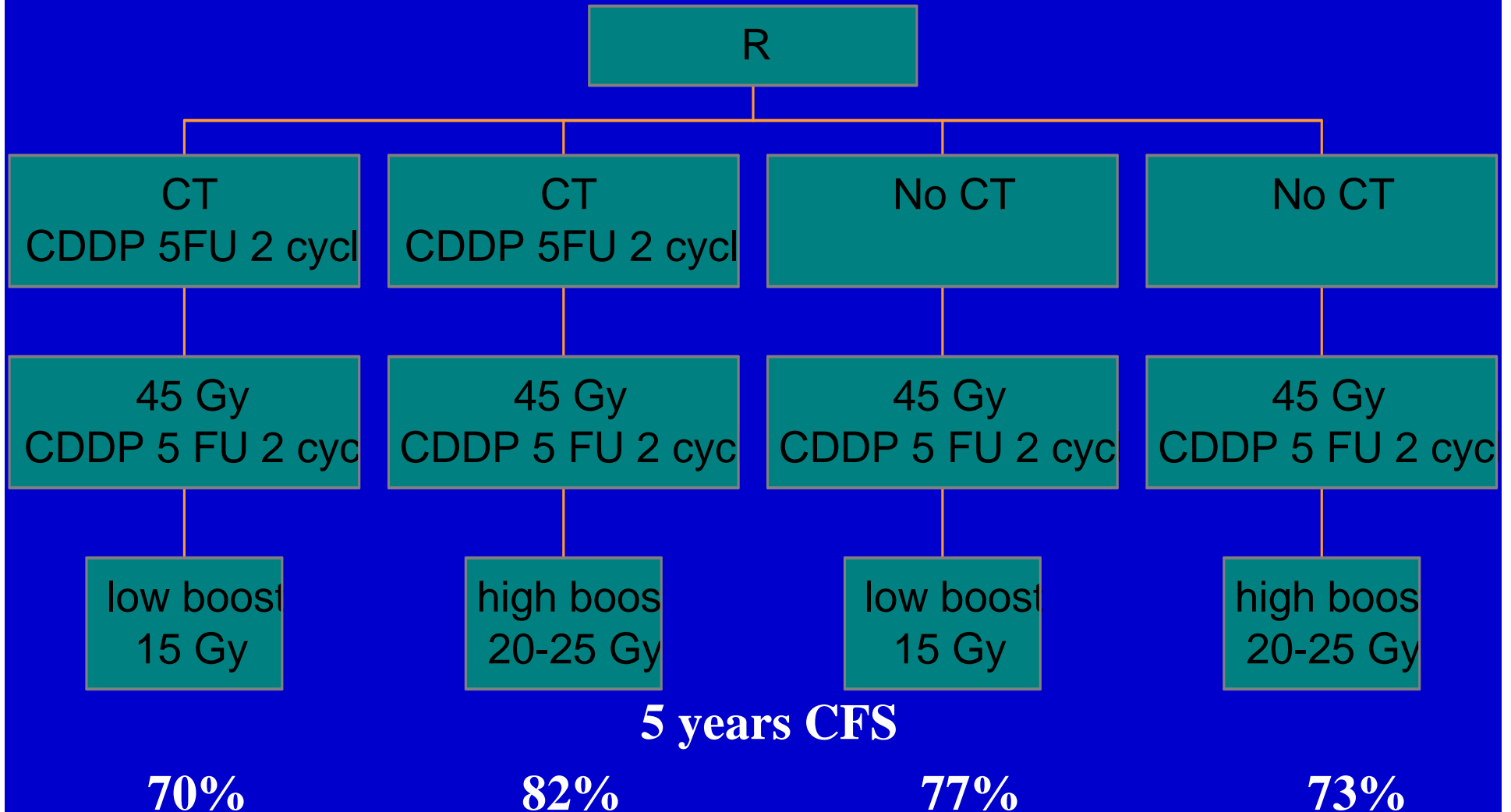

RTOG 9811 Time to Colostomy

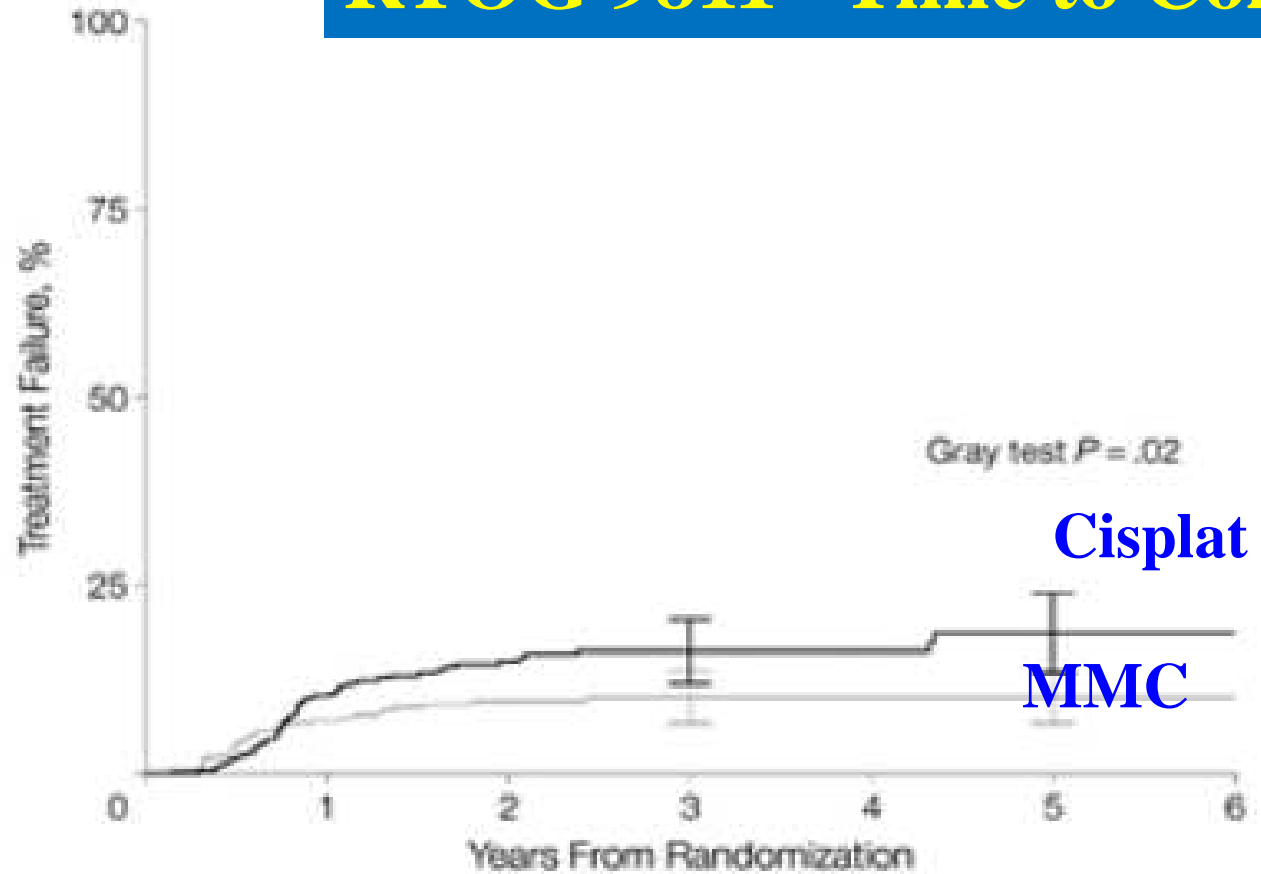

RTOG 9811 Ajani JA et al JAMA 2008

RTOG 9811

Disease Free Survival

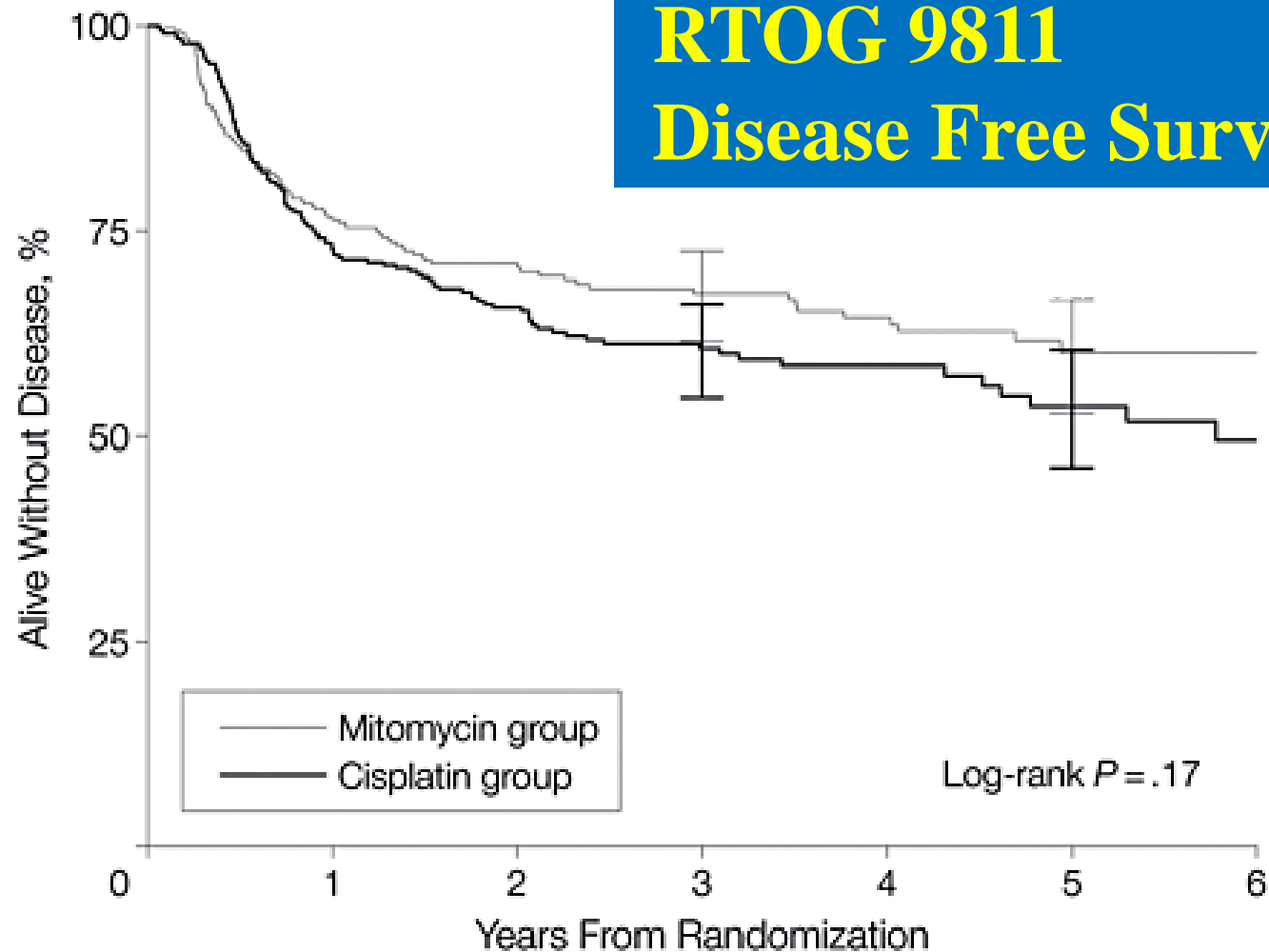

No. at risk

Mitomycin group	324	226	150	114	76	34	10
Cisplatin group	320	223	160	104	62	34	18

Is the Mitomycin C Necessary? Results of RTOG 87-04/ECOG 1289

- 30.6 Gy to pelvis + boost to 50.4 Gy
- 5-FU 1000 mg/m²/d × 4 wk 1 and 5
- Mitomycin C: 10 mg/m² × 2
- 9 Gy with 5-FU & cisplatin for salvage after positive biopsy

	FU+MMC	FU
+ biopsy at 6 weeks	7%	15%
5-year colostomy rate	11%	22%
DFS	67%	50%
Toxicity	23%	7%

Flam M, et al. *J Clin Oncol*. 1996;14:2527-2539.

Problems 2

**What do you do T4 or
locally extensive
disease ?**

T4 disease

- **Surgery**
- **Chemoradiotherapy**
- **Both of the above - ? sequence**

North-west anal cancer audit

- 254 patients (50% RT, 50% CRT) in 12 years (1998 – 2000)
- RT alone mainly given to elderly / frail patients
- 99 (39%) local disease failures (RT 60%, CRT 39%)
 - 94 (95%) occurred within 3 years of treatment
- 3 yr LD failure rate of 49% (RT) and 30% (CRT)
- 73 out of the 99 failures underwent salvage surgery (74%)
- 5 year survival – overall: 52% (CRT – 56%; RT 49%)
- 5 year survival after disease failure : 29% (40% for op pts)

The survival of patients that recur locally is poor and salvage surgery is not always possible and is difficult

Problems 3

What do you do if the disease is too extensive to treat or if metastatic disease is evident?



**42 year old
man with
T4N3 disease**

Neo-adjuvant* / palliative chemotherapy

- MMC
- 5FU (capecitabine)
- Cisplatin



* And then surgery or chemoradiotherapy

Problems 4

**What do you do for patients
with anal cancer and
connective tissue
diseases?**

Anal cancer / SLE / Immunosuppression

- AP resection
- Chemoradiotherapy
 - But proceed with **caution** after discussing the case with the rheumatologist and stopping / reducing the immunosuppressant if possible. Keep the treatment volume as small as possible. Probably tamper the chemo doses.

Anal Canal Cancer and Chemoradiation Treatment in Two Patients with SLE treated by Chronic Therapeutic Immunosuppression
Khoo, Saunders, Gowda, Price, Cummings; Clinical Oncology, 2004.

IMRT in anal cancer

- New application gaining support
- Studies show reduced toxicity rates with comparable local control and survival statistics.
- *Chen et al.* Conventional AP/ PA pelvic fields vs. Conformal avoidance IMRT planning
 - Comparable PTV coverage:
 - IMRT plan: 97-98% of PTV at 90% prescribed dose
 - Conventional AP/PA: 94% of PTV at 90% prescribed dose
 - IMRT spared femoral heads 58-59% vs. 71-72% of prescribed dose and genitalia 55-63% vs. 78-97% with conventional planning

Multicenter experience with IMRT for anal cancer

- 53 patients treated at three academic medical centers with IMRT and chemotherapy for definitive treatment of anal cancer.
- Response
 - Complete response in 92%
 - Local recurrence rate 13% @ 18 months
 - 18-month colostomy free survival 83.7%
 - 18-month distant recurrence free survival 92.3%

(Salama et al., 2007)

Thoughts

- No longer feasible to think that one size fits all in anal cancer
- We improved overall 3 year DFS from 54% (ACT I) to 74% (ACT II)
- We took 7 years to do ACT II
- We probably need international collaboration for next studies

Radiotherapy strategies which need exploring

- Optimization of radiotherapy
(optimal dose/ fractionation/ concomitant boost/ brachytherapy)
- Optimal field sizes
- Evaluation of new radiosensitization protocols
(oxaliplatin, irinotecan, taxanes)
- Optimization of radiotherapy techniques
(IMRT/VMAT/Brachytherapy)

A good **Multi-Disciplinary Team (MDT)** is essential to provide the best treatment for patients of Anal cancers



NICE CRC guidance (May 2004) advises that treatment is carried out in experienced units where cases are discussed in MDTs

Thank you

Surgeon, oncologist, radiologist, pathologist